

## 2色切替 円螺旋組(2)

## 2 colour switching in a flat circle spiral (2)

Circles were missing for circle Bs at the bottom of pages 27, 28 and 29.

27-29頁の一番下のBに が抜けていました。

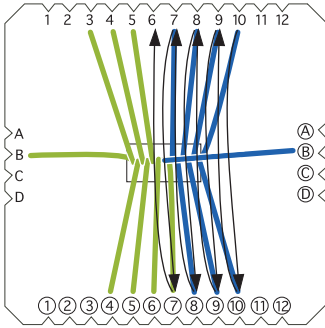

- (4) ⑦ → 6, 7 → ⑦  
 ⑧ → 7, 8 → ⑧  
 ⑨ → 8, 9 → ⑨  
 ⑩ → 9, 10 → ⑩

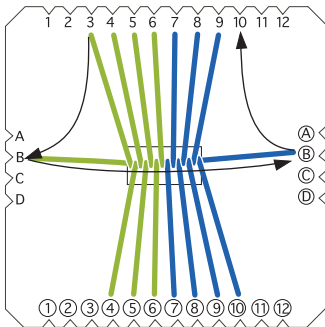
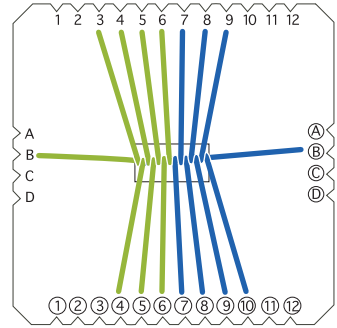

- (5) ⑩ → 10  
 B → ⑩  
 3 → B

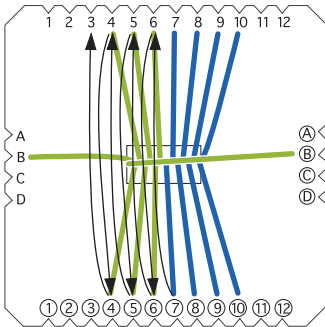
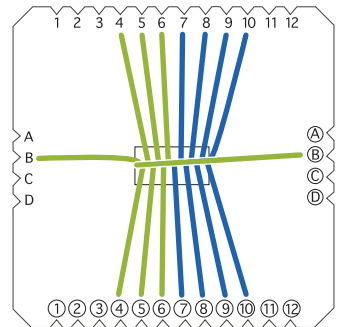

- (6) ④ → 3, 4 → ④  
 ⑤ → 4, 5 → ⑤  
 ⑥ → 5, 6 → ⑥  
 ⑦ → 6

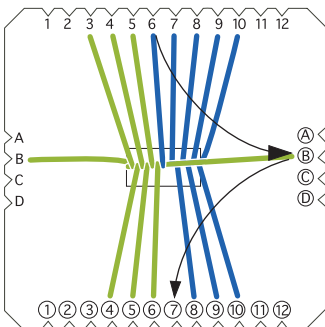
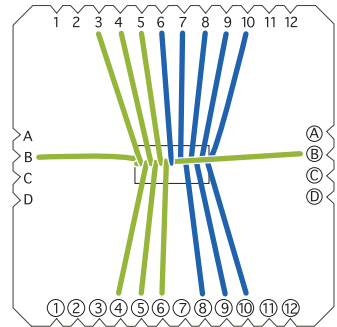

- (7) ⑩ → ⑦  
 6 → ⑩

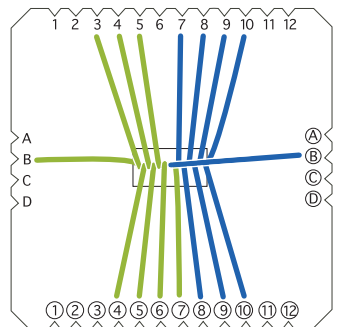

# 2色切替 円螺旋組(3)

# 2 colour switching in a flat circle spiral (3)

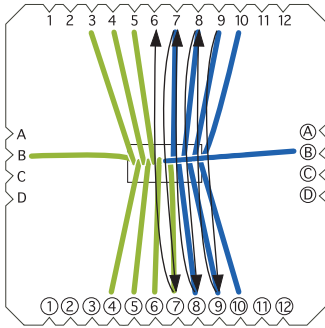

- (8) ⑦ → 6, 7 → ⑦  
 ⑧ → 7, 8 → ⑧  
 ⑨ → 8, 9 → ⑨

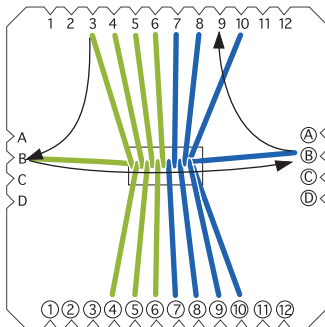
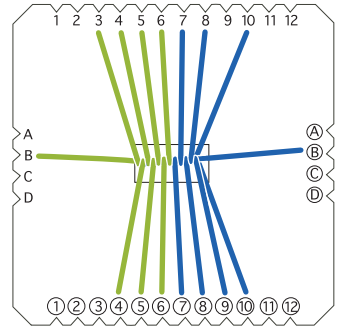

- (9) ⑩ → 9  
 B → ⑩  
 3 → B

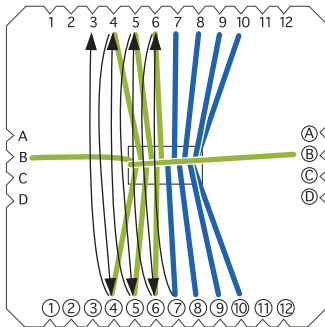
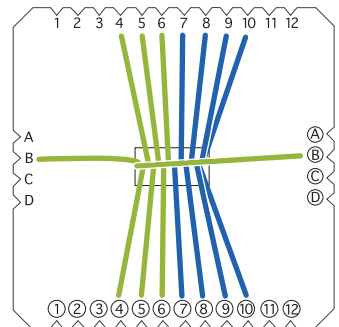

- (10) ④ → 3, 4 → ④  
 ⑤ → 4, 5 → ⑤  
 ⑥ → 5, 6 → ⑥  
 ⑦ → 6

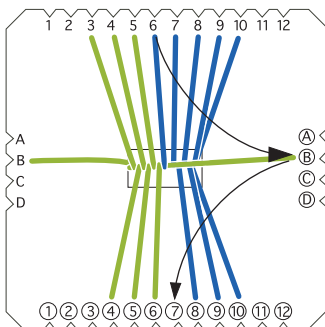
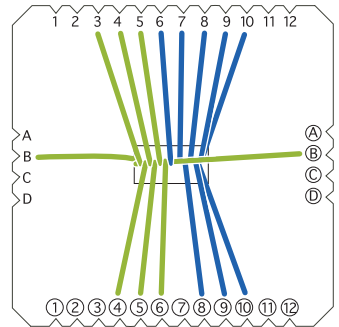

- (11) ⑩ → ⑦  
 6 → ⑩

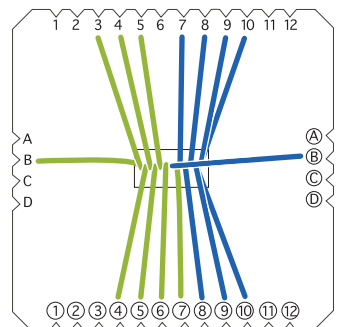

# 2色切替 円螺旋組(4)

# 2 colour switching in a flat circle spiral (4)

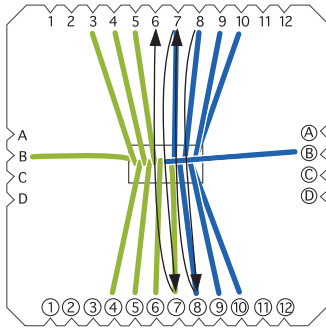

(12) ⑦ → 6, 7 → ⑦  
 ⑧ → 7, 8 → ⑧

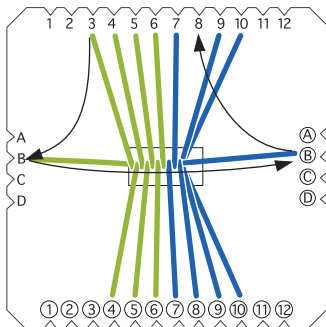
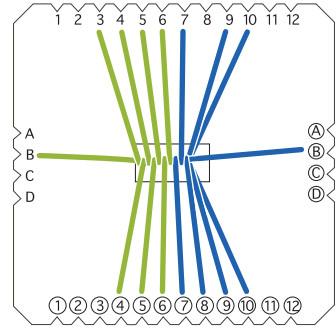

(13) ⑧ → 8  
 B → ⑧  
 3 → B

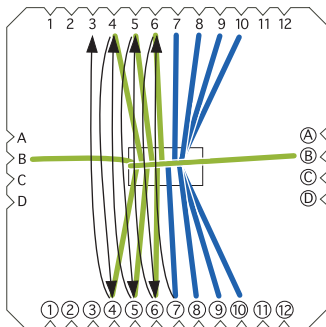
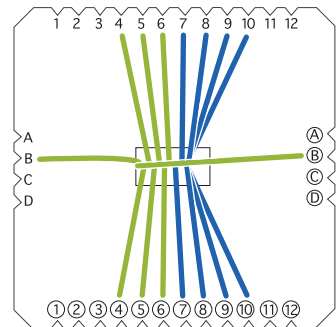

(14) ④ → 3, 4 → ④  
 ⑤ → 4, 5 → ⑤  
 ⑥ → 5, 6 → ⑥  
 ⑦ → 6

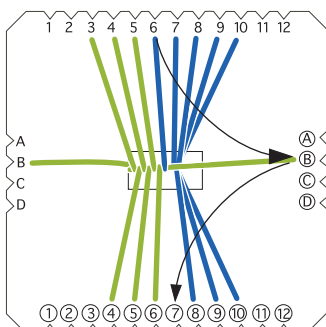
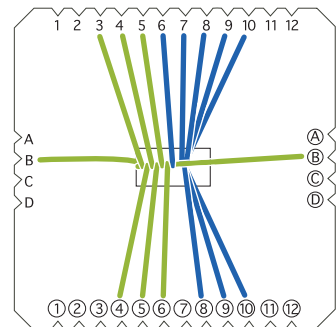

(15) ⑦ → ⑦  
 6 → ⑦

